



Victoria™ G5 Series

Project Name: _____

CATALOG: _____

NOTES: _____

LED Linear Universal Fixture

Key Features

- up to 150 LPW QuickLynk™ Technology
- Low Power | Medium Power | High Power
- X, L & T Interconnections
- 2', 3', 4', & 8' Lengths
- 3000K | 4000K | 5000K | 5700K | 6500K
- 120-277V
- Indoor/Outdoor
- IP66 | ETL | RoHS
- Up to 5yr warranty

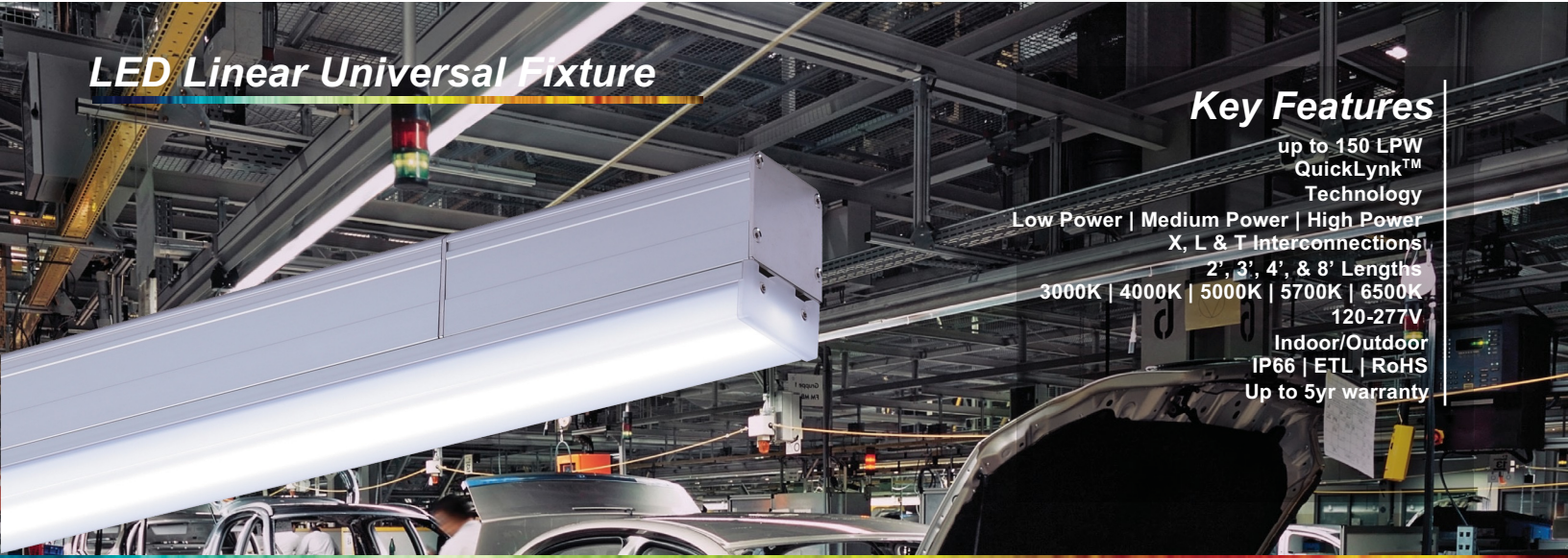

IP66



DESCRIPTION

The Victoria™ G5 Series LUF (Linear Universal Fixture) is the industry's breakthrough innovative engineered Universal line voltage modular linear system that combines sophisticated LED technology with impressive scalability, flexibility and QuickLynk™ technology assembly. With an industry leading 150 LPW, this premium fixture comes in 2', 3', 4' and 8' linear lengths and X | L | T Connect junctions for added versatility to perform complex lighting tasks. The precisely engineered and rigid aluminum plug-and-play fixture makes for a quick and cost saving installations of end-to-end continuous even illumination without dark areas or bright spots. With up to 600' of continuous light (see table on page 3), the IP66 Victoria Linear Series is your indoor/outdoor solution for supermarkets, c-stores, department stores, warehouses, distribution centers, trade centers, exhibition halls, office buildings. Optional motion sensors integrate with energy management systems (EMS) and IoT for controlling capabilities, increasing energy savings and overall life-cycle costs for your project.

CONSTRUCTION

The sleek and strong aluminum trunk body has been engineered for continuous linking rows with premium heat dissipation and high rigidity against possible twists. Plug-and-play QuickLynk™ technology interconnection design makes each light fixture's installation simple and quick without dark areas at all junctions. IP66 rated for indoor/outdoor applications.

OPTICS

Industry leading 150 LPW LED illumination efficiency gives you flicker free light with up to 1,875 lumens per foot. Low, medium and high power options for overall power energy optimization with consistent light output. Frosted lens and 5000 Kelvin temperature standard with additional color temperatures available. Standard 130 degree wide beam angle with 10% uplight.

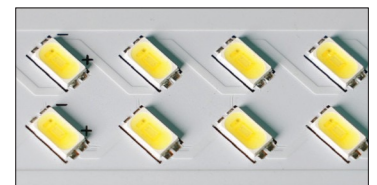

ELECTRICAL

Input Voltage: 120-277V 50/60Hz; Power Factor: > 0.9 at full load; Total Harmonic Distortion: < 20%; Input Power: Stays constant over life; Operating Temperature Range: -40°F to +150°F; Designed with standard 0-10V dimming capabilities.



INSTALLATION

Simple and quick linkable installation with Plug-and-play QuickLynk™ interconnection designed for surface, suspension and pendant mounting. UL approved waterproof IP66 quick connect for continuous lighting up to 600 ft.

ORDERING LOGIC

HIGH POWER (up to 1875 Lumens per foot)

Example Catalog Number: VLH8-98W50KI6-F-E1XC

SERIES	LENGTH	WATTAGE	COLOR TEMP	IP	LENS & COVER	OPTIONS	MOUNTING
VLH (High Power)	2 (2 Feet)	25W (25 Watts)	30K (3000K)	I6 (IP66)	F (Frosted)	X (Internal Control Only)	C (Ceiling Mount)
	3 (3 Feet)	38W (38 Watts)	40K (4000K)		C (Clear)*	M1X (Motion Sensor Position 1)	P (Pendant Mount)
	4 (4 Feet)	50W (50 Watts)	50K (5000K)		X (Lens Type)	M2X (Motion Sensor Position 2)	S (Suspension Mount)
	8 (8 Feet)	98W (98 Watts)	57K (5700K)* 65K (6500K)*			M3X (Motion Sensor Position 3) M4X (Motion Sensor Position 4) EX (Emergency Battery) E1X (Motion Sensor Position 1 w/ Emergency Battery) E2X (Motion Sensor Position 2 w/ Emergency Battery) E3X (Motion Sensor Position 3 w/ Emergency Battery) E4X (Motion Sensor Position 4 w/ Emergency Battery)	W (Wall Mount)

MEDIUM POWER (up to 1300 Lumens per foot)

Example Catalog Number: VLM4-36W40KI6-F-E4XC

SERIES	LENGTH	WATTAGE	COLOR TEMP	IP	LENS & COVER	OPTIONS	MOUNTING
VLM (Med. Power)	2 (2 Feet)	18W (18 Watts)	30K (3000K)	I6 (IP66)	F (Frosted)	X (Internal Control Only)	C (Ceiling Mount)
	3 (3 Feet)	27W (27 Watts)	40K (4000K)		C (Clear)*	M1X (Motion Sensor Position 1)	P (Pendant Mount)
	4 (4 Feet)	36W (36 Watts)	50K (5000K)		X (Lens Type)	M2X (Motion Sensor Position 2)	S (Suspension Mount)
	8 (8 Feet)	72W (72 Watts)	57K (5700K)* 65K (6500K)*			M3X (Motion Sensor Position 3) M4X (Motion Sensor Position 4) EX (Emergency Battery) E1X (Motion Sensor Position 1 w/ Emergency Battery) E2X (Motion Sensor Position 2 w/ Emergency Battery) E3X (Motion Sensor Position 3 w/ Emergency Battery) E4X (Motion Sensor Position 4 w/ Emergency Battery)	W (Wall Mount)

LOW POWER (up to 680 Lumens per foot)

Example Catalog Number: VLL3-14W30KI6-F-E2XC

SERIES	LENGTH	WATTAGE	COLOR TEMP	IP	LENS & COVER	OPTIONS	MOUNTING
VLL (Low Power)	2 (2 Feet)	09W (9 Watts)	30K (3000K)	I6 (IP66)	F (Frosted)	X (Internal Control Only)	C (Ceiling Mount)
	3 (3 Feet)	14W (14 Watts)	40K (4000K)		C (Clear)*	M1X (Motion Sensor Position 1)	P (Pendant Mount)
	4 (4 Feet)	18W (18 Watts)	50K (5000K)		X (Lens Type)	M2X (Motion Sensor Position 2)	S (Suspension Mount)
	8 (8 Feet)	36W (36 Watts)	57K (5700K)* 65K (6500K)*			M3X (Motion Sensor Position 3) M4X (Motion Sensor Position 4) EX (Emergency Battery) E1X (Motion Sensor Position 1 w/ Emergency Battery) E2X (Motion Sensor Position 2 w/ Emergency Battery) E3X (Motion Sensor Position 3 w/ Emergency Battery) E4X (Motion Sensor Position 4 w/ Emergency Battery)	W (Wall Mount)

PERFORMANCE DATA

	Length (ft)	Wattage (W)	Watts/Foot	CCT	LPW	Lumens	LPF	CRI	Dimensions (in)	
									Weight (lbs.)	(LxWxD)
High Power (VLH)	2	25	12.50	3000	130	3250	1620	85	4.2	24x2.1x2.9
				4000	130	3250	1620	85		
				5000	145	3620	1800	85		
				5700*	144	3600	1800	85		
	3	38	12.67	6500*	144	3600	1800	85		
				3000	133	5070	1620	85		
				4000	133	5070	1620	85		
				5000	148	5640	1800	85		
	4	50	12.50	5700*	148	5624	1875	85		
				6500*	148	5624	1875	85		
				3000	132	6620	1620	85		
				4000	132	6620	1620	85		
	8	98	12.25	5000	148	7400	1800	85		
				5700*	150	7500	1875	85		
				6500*	150	7500	1875	85		
				3000	132	12710	1620	85		
				4000	132	12710	1620	85		
				5000	147	14150	1800	85		
				5700*	150	14700	1838	85		
				6500*	150	14700	1838	85		

	Length (ft)	Wattage (W)	Watts/Foot	CCT	LPW	Lumens	LPF	CRI	Dimensions (in)	
									Weight (lbs.)	(LxWxD)
Mid Power (VLM)	2	18	9.00	3000	131	2350	1200	85	4.2	24x2.1x2.9
				4000	142	2550	1200	85		
				5000	145	2610	1350	85		
				5700*	142	2560	1300	85		
	3	27	9.00	6500*	142	2560	1300	85		
				3000	133	3600	1200	85		
				4000	133	3600	1200	85		
				5000	148	4000	1350	85		
	4	36	9.00	5700*	146	3938	1300	85		
				6500*	146	3938	1300	85		
				3000	135	4860	1200	85		
				4000	135	4860	1200	85		
	8	72	9.00	5000	150	5400	1350	85		
				5700*	148	5313	1300	85		
				6500*	148	5313	1300	85		
				3000	135	9710	1200	85		
				4000	135	9710	1200	85		
				5000	150	10800	1350	85		
				5700*	148	10656	1300	85		
				6500*	148	10656	1300	85		

	Length (ft)	Wattage (W)	Watts/Foot	CCT	LPW	Lumens	LPF	CRI	Dimensions (in)	
									Weight (lbs.)	(LxWxD)
Low Power (VLL)	2	9	4.50	3000	124	1120	560	85	4.2	24x2.1x2.9
				4000	137	1230	600	85		
				5000	138	1240	680	85		
				5700*	136	1224	630	85		
	3	14	4.67	6500*	136	1224	630	85		
				3000	133	1860	600	85		
				4000	133	1860	600	85		
				5000	148	2070	680	85		
	4	18	4.50	5700*	139	1946	630	85		
				6500*	139	1946	630	85		
				3000	133	2390	600	85		
				4000	133	2390	600	85		
	8	36	4.50	5000	148	2660	680	85		
				5700*	139	2502	630	85		
				6500*	139	2502	630	85		
				3000	133	4790	600	85		
				4000	133	4790	600	85		
				5000	148	5320	680	85		
				5700*	139	5004	630	85		
				6500*	139	5004	630	85		





**CONTINUES
LIGHT TABLE**

	Voltage	Total Length (ft)
VLL	120	270
	277	620
VLM	120	135
	277	300
VLH	120	95
	277	225

SENSOR OPTIONS

VLA-BAS-500	PIR occupancy sensor with SLV for on/off switching control
VLA-DIM-509S	PIR occupancy sensor, SLV & AO for dimming control, programmable Motion sensor, IP65 OS-NET, PIR, SLV+AO, ALS, Hybrid, programmable
VLA-OSN-509	Remote Control, TRANS Sensor for VLA-DIM-509s
VLA-MS-280	Remote Control, OS-NET for VLA-OSN-509
VLA-MS-281	Remote Control, OS-NET for VLA-OSN-509



POWER CORDS & ACCESSORIES

VLA-P-X		X Connector
VLA-P-T		T Connector
VLA-P-IC		IP66 power cap
VLA-P-PC6		Power Cord 6 ft
VLA-P-IC6		Interconnecting Power Cord 6 ft

COVER ACCESSORIES

VLA-C-F		Front Cover
VLA-C-E		End Cover
VLA-C-I-2		Interconnection Cover For 2ft
VLA-C-I-348		Interconnection Cover For 3/4/8ft
VLA-C-IC-2		2 ft Interconnection Cover Ceiling
VLA-C-IC-348		Interconnection Cover Ceiling For 3/4/8ft
VLA-C-X		Cover for X Connect
VLA-C-T		Cover for T Connect
VLA-C-L		Cover for L Connect

MOUNTING ACCESSORIES

VLA-M-CS		Clip Suspension/Ceiling
VLA-M-CP		Clip-P Pendant
VLA-M-CW		Clip-W Suspension/Ceiling
VLA-M-CN		Clip-knuckle Mount
VLA-M-SWY		Suspension Wire 5ft Y-style
VLA-M-SW		Suspension Wire 5ft
VLA-M-JB		J-box
VLA-M-SC		Pendant Mount Screw-Rod & Cap 3/8''(3ft)

DIMENSIONS

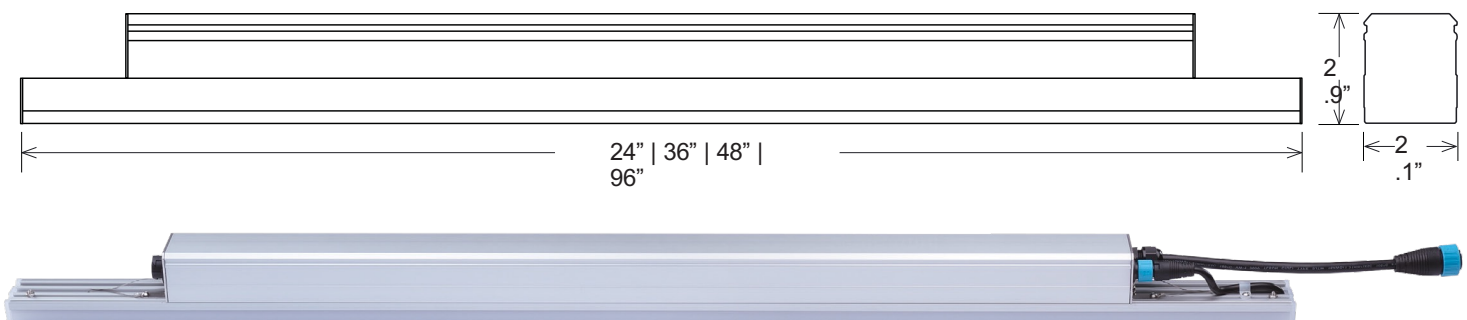
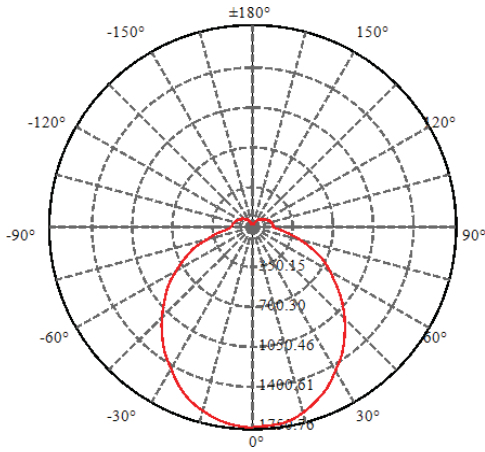
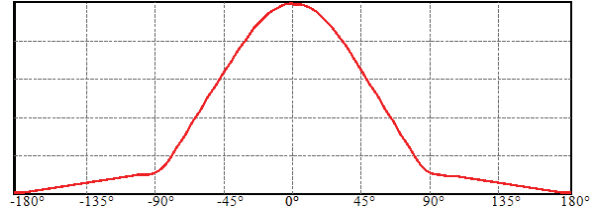

DIAGRAM FOR LUMINOUS INTENSITY DISTRIBUTION

ISOCANDELA DIAGRAM C0 / 180



CARTESIAN COORDINATES C0 / 180



MOTION SENSOR DIMENSIONS

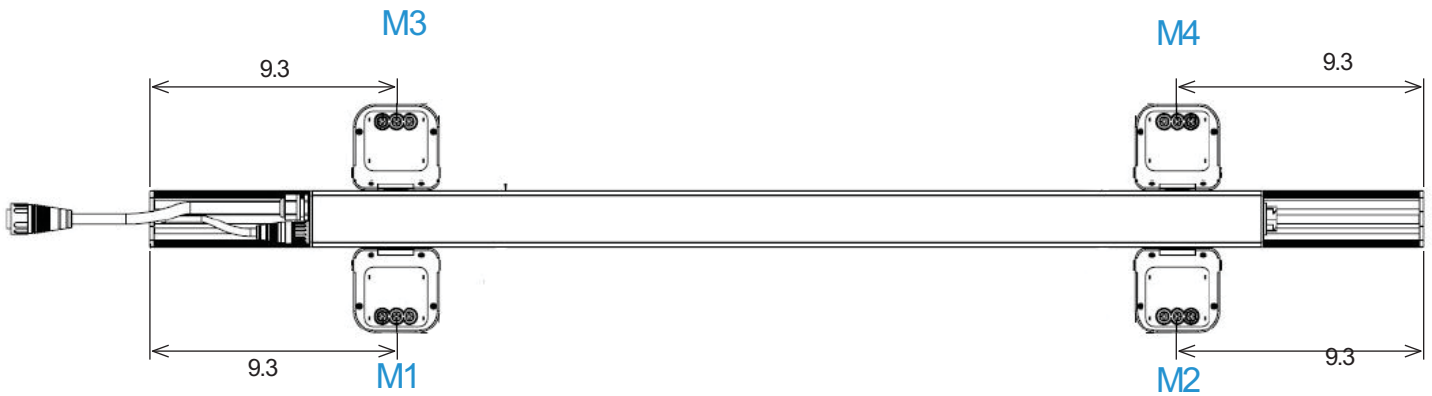

LINEAR QuickLynk™ INTERCONNECTION SYSTEM

Advanced engineered linear system delivers unmatched continuous light.

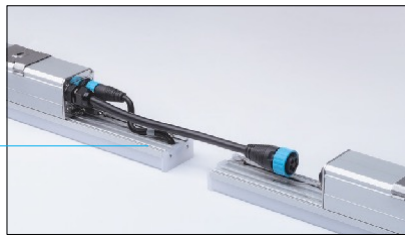

IP66 Plug-and-play connectivity ensures indoor/outdoor applications.

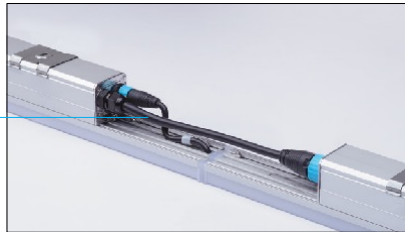

Rigid Interconnection Cover strengthens, protects and prevents twisting and debris accumulation.

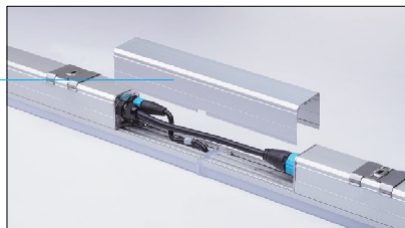

Seamless Smooth/Flat Surfaces allow for a variety of applications.

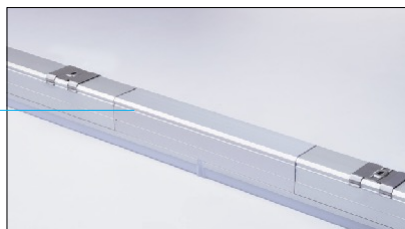

X | L | T CONNECT SYSTEM

X
Junction

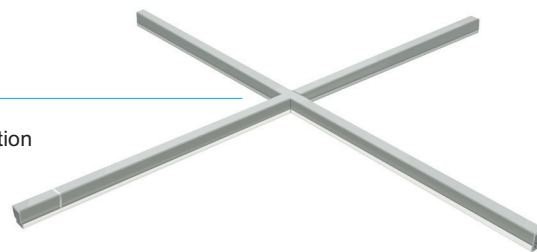

L
Junction

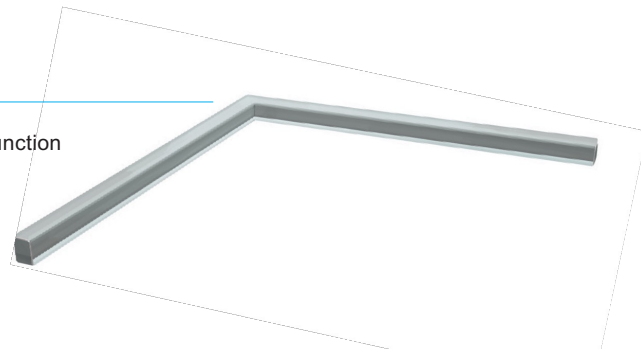

T
Junction

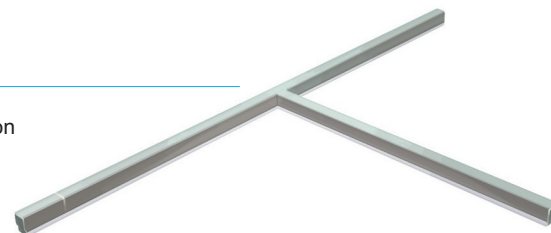

MOUNTING OPTIONS

Flush Mount

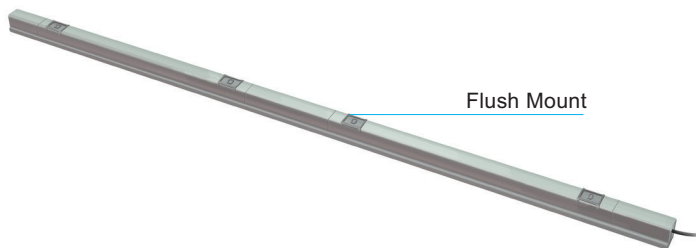

Pendant Mount

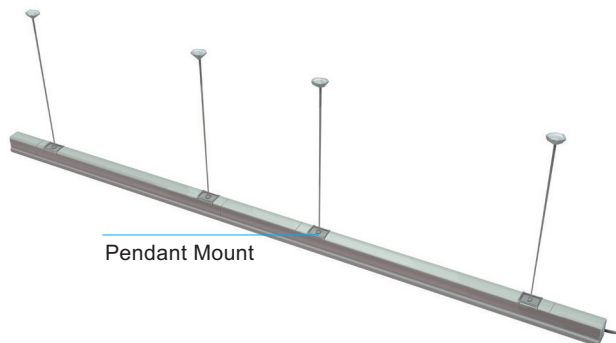

Suspension Mount

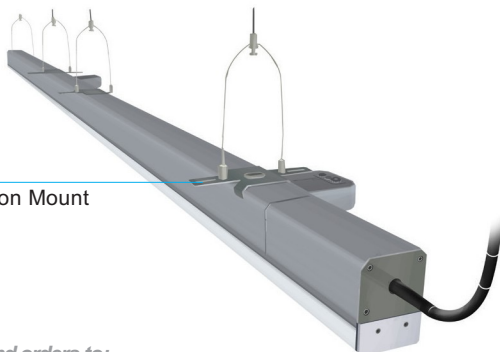

Soffit Mount

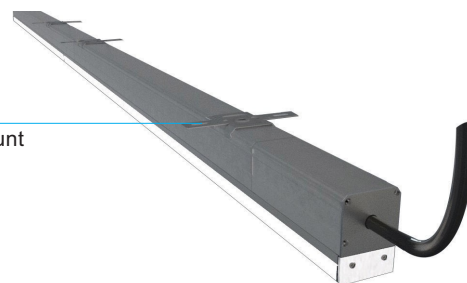

Please send orders to:
Email: order@vm5lighting.com

*For detailed instructions, refer to the Installation Instructions