



# Victoria™ G5 Series

PROJECT NAME \_\_\_\_\_

CATALOG \_\_\_\_\_

NOTES \_\_\_\_\_

## LED Linear Universal Fixture

### Key Features

up to 150 LPW  
 DLC5.0 Premium  
 QuickLynk™ Technology  
 Low Power | Medium Power | High Power  
 X, L & T Interconnections  
 2, 3, 4, & 8' Lengths  
 3000K | 4000K | 5000K | 5700K | 6500K  
 120-277V  
 Indoor/Outdoor  
 IP66 | EIL | RoHS  
 Upto 5yr warranty



## DESCRIPTION

The Victoria™ G5 Series LUF (Linear Universal Fixture) is the industry's breakthrough innovative engineered Universal line voltage modular linear system that combines sophisticated LED technology with impressive scalability, flexibility and QuickLynk™ technology assembly. With an industry leading 150 LPW, this premium fixture comes in 2, 3, 4' and 8' linear lengths and X | L | T Connect junctions for added versatility to perform complex lighting tasks. The precisely engineered and rigid aluminum plug-and-play fixture makes for a quick and cost saving installations of end-to-end continuous even illumination without dark areas or bright spots. With up to 600' of continuous light (see table on page 3), the IP66 Victoria Linear Series is your indoor/outdoor solution for supermarkets, c-stores, department stores, warehouses, distribution centers, trade centers, exhibition halls, office buildings. Optional motion sensors integrate with energy management systems (EMS) and IoT for controlling capabilities, increasing energy savings and overall life-cycle costs for your project.

## CONSTRUCTION

The sleek and strong aluminum trunk body has been engineered for continuous linking rows with premium heat dissipation and high rigidity against possible twists. Plug-and-play QuickLynk™ technology interconnection design makes each light fixture's installation simple and quick without dark areas at all junctions. IP66 rated for indoor/outdoor applications.

## OPTICS

Industry leading 150 LPW LED illumination efficiency gives you flicker free light with up to 1,875 lumens per foot. Low, medium and high power options for overall power energy optimization with consistent light output. Frosted lens and 5000 Kelvin temperature standard with additional color temperatures available. Standard 130 degree wide beam angle with 10% uplight.

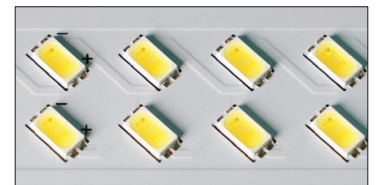

## ELECTRICAL

Input Voltage: 120-277V 50/60Hz; Power Factor: > 0.9 at full load; Total Harmonic Distortion: < 20%; Input Power: Stays constant over life; Operating Temperature Range: -40°F to +150°F; Designed with standard 0-10V dimming capabilities.



## INSTALLATION

Simple and quick linkable installation with Plug-and-play QuickLynk™ interconnection designed for surface, suspension and pendant mounting. UL approved waterproof IP66 quick connect for continuous lighting up to 600'.

# ORDERING LOGIC

## HIGH POWER (up to 1875 Lumens per foot)

Example Catalog Number: VLH898W50K6FE1C

SERIES	LENGTH	WATTAGE	COLORTEMP	IP	LENS&COVER	OPTIONS	MOUNTING
VLH (High Power)	2 (2Feet)	25W (25Watts)	30K (3000K)	I6 (IP66)	F (Frosted)	X (Internal Control Only)	C (Ceiling Mount)
	3 (3Feet)	38W (38Watts)	40K (4000K)		C (Clear)*	M1X (Motion Sensor Position 1)	P (Pendant Mount)
	4 (4Feet)	50W (50Watts)	50K (5000K)		X (Lens Type)	M2X (Motion Sensor Position 2)	S (Suspension Mount)
	8 (8Feet)	98W (98Watts)	57K (5700K)*		M3X (Motion Sensor Position 3)	W (Wall Mount)	
			65K (6500K)*		M4X (Motion Sensor Position 4)		
						E1X (Emergency Battery)	
						E1X (Motion Sensor Position 1 w/ Emergency Battery)	
						E2X (Motion Sensor Position 2 w/ Emergency Battery)	
						E3X (Motion Sensor Position 3 w/ Emergency Battery)	
						E4X (Motion Sensor Position 4 w/ Emergency Battery)	

## MEDIUM POWER (up to 1300 Lumens per foot)

Example Catalog Number: VLM436W40K6FE4C

SERIES	LENGTH	WATTAGE	COLORTEMP	IP	LENS&COVER	OPTIONS	MOUNTING
VLM (Medium Power)	2 (2Feet)	18W (18Watts)	30K (3000K)	I6 (IP66)	F (Frosted)	X (Internal Control Only)	C (Ceiling Mount)
	3 (3Feet)	27W (27Watts)	40K (4000K)		C (Clear)*	M1X (Motion Sensor Position 1)	P (Pendant Mount)
	4 (4Feet)	36W (36Watts)	50K (5000K)		X (Lens Type)	M2X (Motion Sensor Position 2)	S (Suspension Mount)
	8 (8Feet)	72W (72Watts)	57K (5700K)*		M3X (Motion Sensor Position 3)	W (Wall Mount)	
			65K (6500K)*		M4X (Motion Sensor Position 4)		
						E1X (Emergency Battery)	
						E1X (Motion Sensor Position 1 w/ Emergency Battery)	
						E2X (Motion Sensor Position 2 w/ Emergency Battery)	
						E3X (Motion Sensor Position 3 w/ Emergency Battery)	
						E4X (Motion Sensor Position 4 w/ Emergency Battery)	

## LOW POWER (up to 680 Lumens per foot)

Example Catalog Number: VLL314W30K6FE2C

SERIES	LENGTH	WATTAGE	COLORTEMP	IP	LENS&COVER	OPTIONS	MOUNTING
VLL (Low Power)	2 (2Feet)	9W (9Watts)	30K (3000K)	I6 (IP66)	F (Frosted)	X (Internal Control Only)	C (Ceiling Mount)
	3 (3Feet)	14W (14Watts)	40K (4000K)		C (Clear)*	M1X (Motion Sensor Position 1)	P (Pendant Mount)
	4 (4Feet)	18W (18Watts)	50K (5000K)		X (Lens Type)	M2X (Motion Sensor Position 2)	S (Suspension Mount)
	8 (8Feet)	36W (36Watts)	57K (5700K)*		M3X (Motion Sensor Position 3)	W (Wall Mount)	
			65K (6500K)*		M4X (Motion Sensor Position 4)		
						E1X (Emergency Battery)	
						E1X (Motion Sensor Position 1 w/ Emergency Battery)	
						E2X (Motion Sensor Position 2 w/ Emergency Battery)	
						E3X (Motion Sensor Position 3 w/ Emergency Battery)	
						E4X (Motion Sensor Position 4 w/ Emergency Battery)	

\* NOT LISTED

# PERFORMANCE DATA

	Length (ft)	Wattage (W)	Watts/Foot (W)	CCT	LPW	Lumens	LPF	CRI	Weight (lbs.)	Dimensions (in.)
										(LxWxD)
High Power (VLH)	2	25	12.50	3000	130	3250	1620	85	4.2	24x2.1x2.9
				4000	130	3250	1620	85		
				5000	145	3620	1800	85		
				5700*	144	3600	1800	85		
				6500*	144	3600	1800	85		
	3	38	12.67	3000	133	5070	1620	85	5.3	36x2.1x2.9
				4000	133	5070	1620	85		
				5000	148	5640	1800	85		
				5700*	148	5624	1875	85		
				6500*	148	5624	1875	85		
	4	50	12.50	3000	132	6620	1620	85	6.6	48x2.1x2.9
				4000	132	6620	1620	85		
				5000	148	7400	1800	85		
				5700*	150	7500	1875	85		
				6500*	150	7500	1875	85		
	8	98	12.25	3000	132	12710	1620	85	11.0	96x2.1x2.9
4000				132	12710	1620	85			
5000				147	14150	1800	85			
5700*				150	14700	1838	85			
6500*				150	14700	1838	85			

	Length (ft)	Wattage (W)	Watts/Foot (W)	CCT	LPW	Lumens	LPF	CRI	Weight (lbs.)	Dimensions (in.)
										(LxWxD)
Mid Power (VLM)	2	18	9.00	3000	131	2350	1200	85	4.2	24x2.1x2.9
				4000	142	2550	1200	85		
				5000	145	2610	1350	85		
				5700*	142	2560	1300	85		
				6500*	142	2560	1300	85		
	3	27	9.00	3000	133	3600	1200	85	5.3	36x2.1x2.9
				4000	133	3600	1200	85		
				5000	148	4000	1350	85		
				5700*	146	3938	1300	85		
				6500*	146	3938	1300	85		
	4	36	9.00	3000	135	4860	1200	85	6.6	48x2.1x2.9
				4000	135	4860	1200	85		
				5000	150	5400	1350	85		
				5700*	148	5313	1300	85		
				6500*	148	5313	1300	85		
	8	72	9.00	3000	135	9710	1200	85	11.0	96x2.1x2.9
4000				135	9710	1200	85			
5000				150	10800	1350	85			
5700*				148	10656	1300	85			
6500*				148	10656	1300	85			

	Length (ft)	Wattage (W)	Watts/Foot (W)	CCT	LPW	Lumens	LPF	CRI	Weight (lbs.)	Dimensions (in.)
										(LxWxD)
Low Power (VLL)	2	9	4.50	3000	124	1120	560	85	4.2	24x2.1x2.9
				4000	137	1230	600	85		
				5000	138	1240	680	85		
				5700*	136	1224	630	85		
				6500*	136	1224	630	85		
	3	14	4.67	3000	133	1860	600	85	5.3	36x2.1x2.9
				4000	133	1860	600	85		
				5000	148	2070	680	85		
				5700*	139	1946	630	85		
				6500*	139	1946	630	85		
	4	18	4.50	3000	133	2390	600	85	6.6	48x2.1x2.9
				4000	133	2390	600	85		
				5000	148	2660	680	85		
				5700*	139	2502	630	85		
				6500*	139	2502	630	85		
	8	36	4.50	3000	133	4790	600	85	11.0	96x2.1x2.9
4000				133	4790	600	85			
5000				148	5320	680	85			
5700*				139	5004	630	85			
6500*				139	5004	630	85			

## CONTINUOUS LIGHT TABLE





	Voltage	Total Length (ft)
VLL	120	270
	277	620
VLM	120	135
	277	300
VLH	120	95
	277	225

\* NOT CLUSTED









## SENSOR OPTIONS

<b>VLBAS600</b>	PR occupancy sensor with SLV for on/off switching control
<b>VLADIM509S</b>	PR occupancy sensor, SLV & AO for dimming control, programmable
<b>VLAOSN609</b>	Motion sensor, F65 OSNET, PR, SLV/AO, ALS, Hybrid, programmable
<b>VLAMS280</b>	Remote Control, TRANS Sensor for VLADIM509s
<b>VLAMS281</b>	Remote Control, OSNET for VLAOSN609









## POWER CORDS & ACCESSORIES

<b>VLAPX</b>		XC Connector
<b>VLAPT</b>		TC Connector
<b>VLAPIC</b>		F66 power cap
<b>VLAPPC6</b>		Power Cord 6ft
<b>VLAPIC6</b>		Interconnecting Power Cord 6ft

## COVER ACCESSORIES

<b>VLACF</b>		Front Cover
<b>VLACE</b>		End Cover
<b>VLACI-2</b>		Interconnection Cover For 2ft
<b>VLACI-348</b>		Interconnection Cover For 3/4/8ft
<b>VLACIC-2</b>		Interconnection Cover Ceiling For 2ft
<b>VLACIC-348</b>		Interconnection Cover Ceiling For 3/4/8ft
<b>VLACX</b>		Cover for XConnect
<b>VLACT</b>		Cover for TCConnect
<b>VLACL</b>		Cover for LConnect

## MOUNTING ACCESSORIES

<b>VLAMCS</b>		Clip Suspension/Ceiling
<b>VLAMCP</b>		Clip PPendant
<b>VLAMCW</b>		Clip WSuspension/Ceiling
<b>VLAMCN</b>		Clipknuckle Mount
<b>VLAMSW</b>		Suspension Wire 5ft Ystyle
<b>VLAMSW</b>		Suspension Wire 5ft
<b>VLAMJB</b>		Jbox
<b>VLAMSC</b>		Pendant Mount Screw Rod & Cap 3/8" (3ft)

## DIMENSIONS

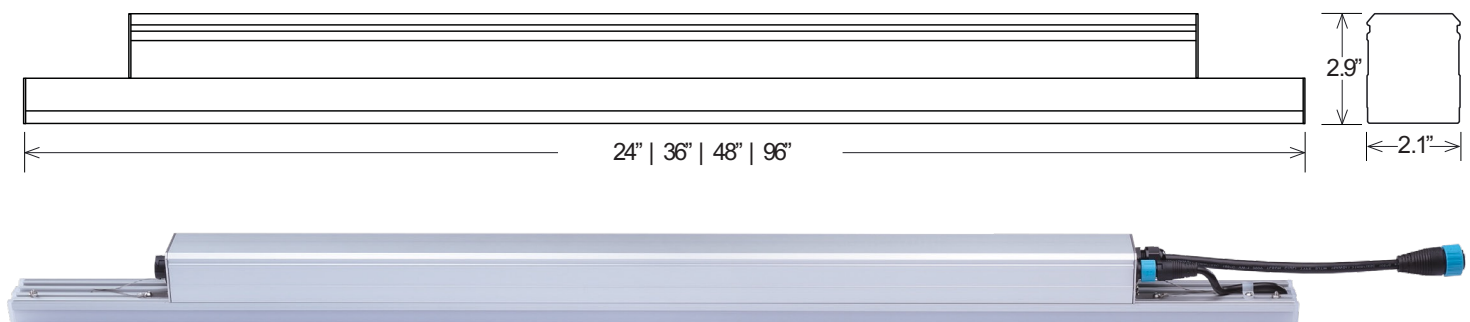

# DIAGRAM FOR LUMINOUS INTENSITY DISTRIBUTION I

ISO CANDELA DIAGRAM C0/ 180

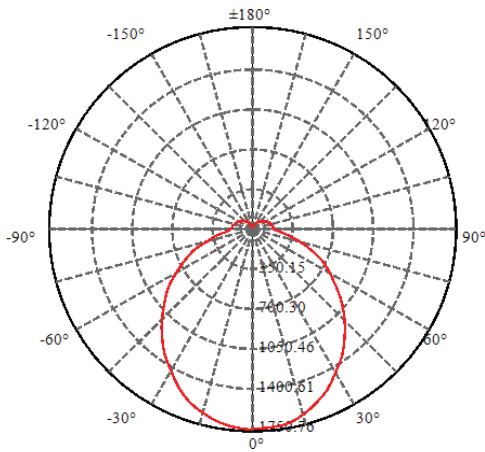

CARTESIAN COORDINATES C0/ 180

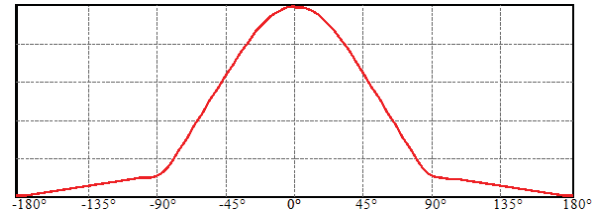

## MOTION SENSOR DIMENSIONS

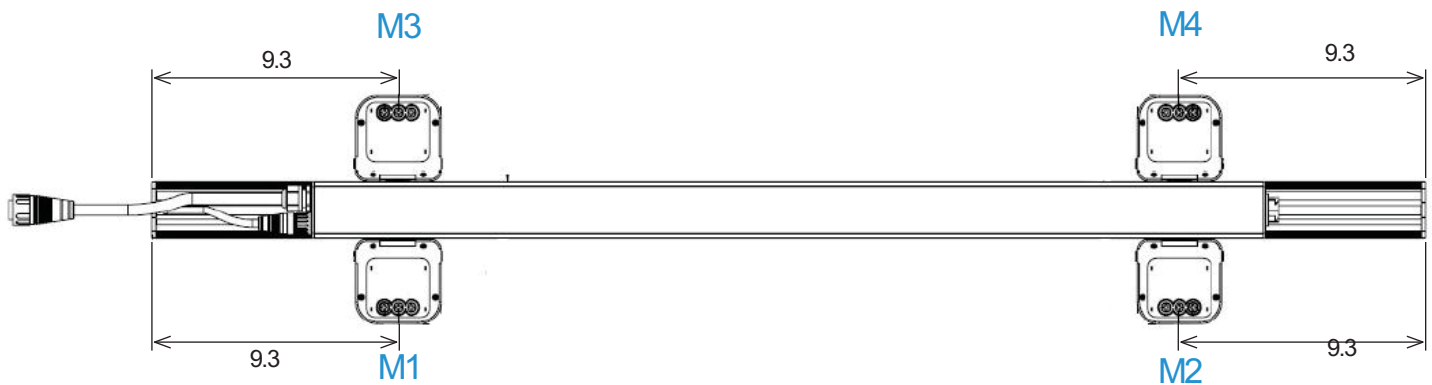

## WARRANTY INFORMATION

	Operating Temp. Deg. F	Warranty Years
<b>VL</b>	-40- 150	7
<b>VLM</b>	-40- 115	7
	-40- 130	5
<b>VLH</b>	-40- 115	7
	-40- 130	5

# LINEAR QuickLynk™ INTERCONNECTION SYSTEM

Advanced engineered linear system delivers unmatched continuous light.

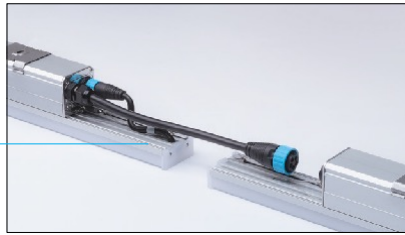

P66 Plug-and-play connectivity ensures indoor/outdoor applications.

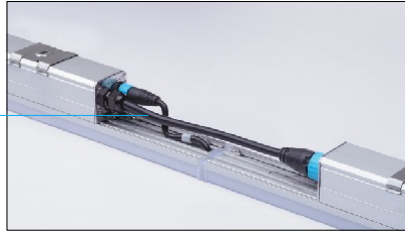

Rigid Interconnection Cover strengthens, protects and prevents twisting and debris accumulation.

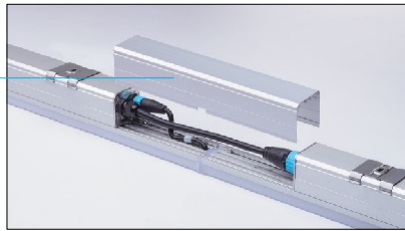

Seamless Smooth Flat Surfaces allow for a variety of applications.

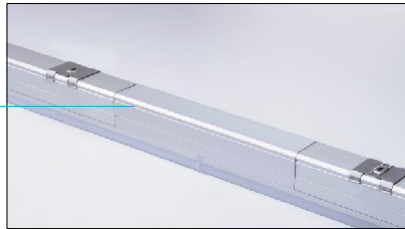

# X | L | T CONNECT SYSTEM

XJunction

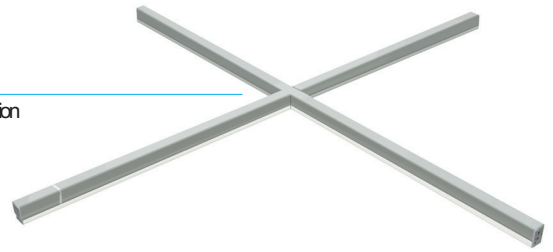

LJunction

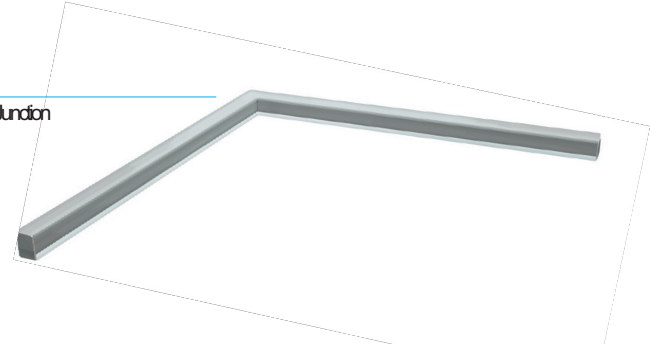

TJunction

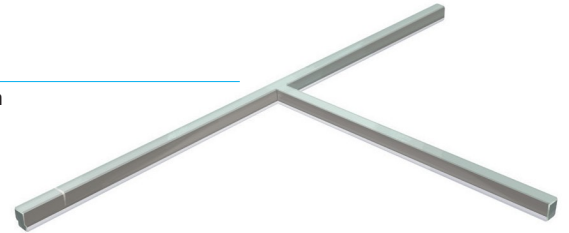

# MOUNTING OPTIONS

Flush Mount

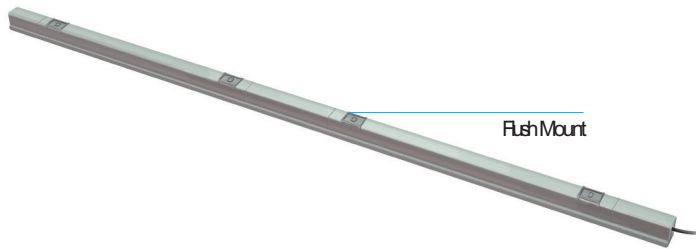

Pendant Mount

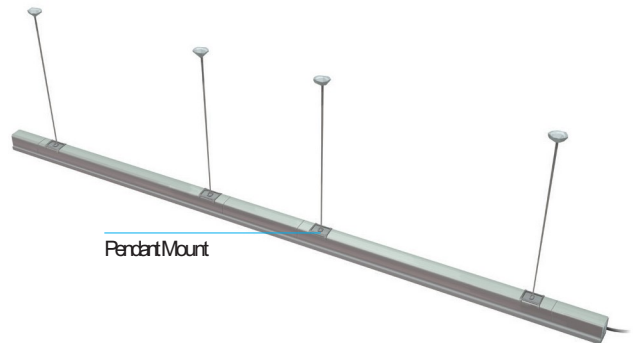

Suspension Mount

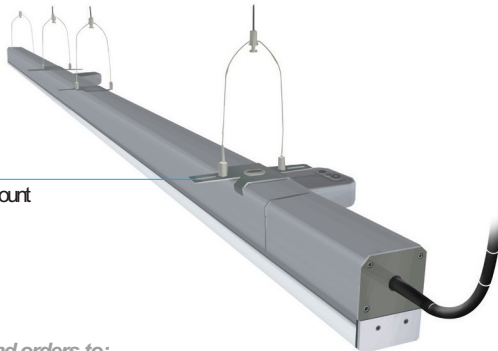

Soffit Mount

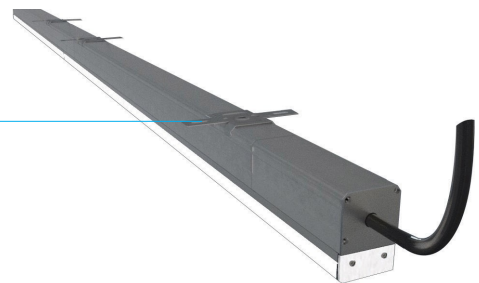

Please send orders to:  
Email: [order@vm5lighting.com](mailto:order@vm5lighting.com)

\*For detailed instructions, refer to the Installation Instructions